



HEIDENHAIN



Product Information

EIB 3391Y

Interface Electronics
as Cable Version

April 2017

EIB 3391Y

- **Interface electronics in D-sub connector housing**
- **Input: EnDat22 interface for specific linear and angle encoder versions**
- **Output: Yaskawa serial interface**

The EIB 3391Y enables you to connect specific linear and angle encoder versions to the servo drives of the Sigma 7 series (series SGD7 and SGDV-0FA01A with v0021 firmware or higher) from Yaskawa. Please note:

- The encoder is adjusted without the EIB directly over the EnDat interface at the encoder, e.g. with the PWM 20. At present, the EIB 3391Y is supported only by the PWM 20.
- The **zero set** function (datum setting) is not supported by the EIB
- The encoder is powered over the EIB (note the encoder's power consumption P_M)

Linear encoders

The EIB supports only the following LIC or LC encoders:

- LIC 2100 with AK LIC 211 scanning head with 50 nm or 100 nm measuring step
- LIC 4100 with AK LIC 411 scanning head with 5 nm measuring step
- LC 115 with 10 nm measuring step
- LC 211 with 10 nm measuring step
- LC 415 with 10 nm measuring step

Please also note:

- A special version of the EIB 3391Y is necessary for every measuring step
- Maximum permissible measuring length
Measuring step 5 nm: < 9 m
Measuring step 10 nm: < 18 m

Angle encoders

The EIB supports angle encoders with position values/rev of 26 to 29 bits. There are limitations to maximum shaft speed (see *Connectable encoders* in the *Specifications*). The following angle encoders are supported:

- RCN 2x10
- RCN 5x10
- RCN 8x10
- ROC 2x10, ROC 7x10
- ECA 4x1x

An angle encoder can be used together with the EIB in a "full closed" application only for position measurement. It cannot be used for a "direct drive" application, i.e. as a motor encoder for commutation.

The adjustment parameters for connection to servo drives from Yaskawa are listed in the S Specifications of the respective encoder.



Input: 15-pin D-sub connector (female)

Output: 15-pin D-sub connector (male)

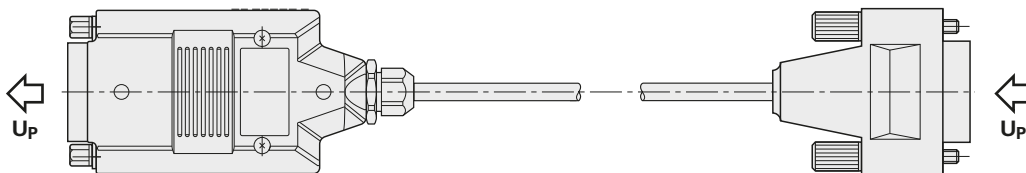

mm

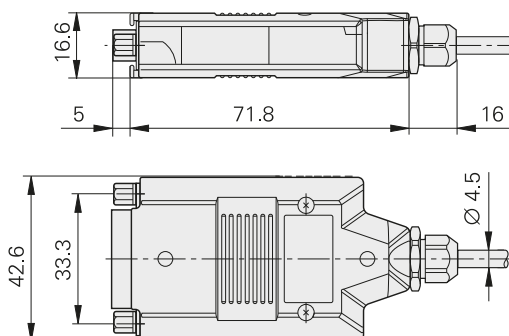
 Tolerancing ISO 8015
 ISO 2768 - m H
 < 6 mm: ±0.2 mm



Specifications	EIB 3391Y
Input	
Interface	EnDat 2.2
Ordering designation	EnDat22
Electrical connection	D-sub connector (female) 15-pin
Cable length	≤ 6 m ¹⁾
Connectable encoders ²⁾	<ul style="list-style-type: none"> • LIC 2100 with 50 nm measuring step • LIC 2100 with 100 nm measuring step • LIC 4100 with 5 nm measuring step • LC 115 with 10 nm measuring step • LC 211 with 10 nm measuring step • LC 415 with 10 nm measuring step • Angle encoders RCN, ROC, ECA with position values per revolution of 26 bits to 29 bits⁶⁾
Output	
Interface	Yaskawa Serial Interface ^{3) 4)}
Electrical connection	D-sub connector (male) 15-pin
Cable length	≤ 10 m ¹⁾
Voltage supply	DC 3.6 V to 14 V ⁵⁾
Power consumption (max.)	3.6 V: 550 mW + P _{Mmax} 14 V: 700 mW + P _{Mmax}
Power consumption (typical)	5 V: 600 mW + P _{Mtyp}
Operating temperature Storage temperature	0 °C to 70 °C -30 °C to 70 °C
Vibration 55 Hz to 2000 Hz Shock 11 ms	100 m/s ² (EN 60068-2-6) 200 m/s ² (EN 60068-2-27)
Protection	IP40
Mass	140 g (EIB without cable)

¹⁾ With HEIDENHAIN cable; greater cable lengths only after consultation with HEIDENHAIN

²⁾ When ordering, please select the measuring step of the encoder (the measuring step determines the EIB 3391Y version required)

³⁾ The "zero set" function is not supported

⁴⁾ HEIDENHAIN recommends clarifying the combination of servo drive, EIB 3391 Y and encoder beforehand with Yaskawa





⁵⁾ Note the encoder supply voltage!

⁶⁾ Maximum permissible shaft speed: 27 bits < 1600 rpm; 28 bits < 800 rpm; 29 bits < 400 rpm

Electrical connection

Pin layout

EIB input



15-pin D-sub connector, female										
  										
	Power supply				Serial data transfer				Other signals	
	4	12	2	10	5	13	8	15	1/3/6/7/9/11/14	
	U_P	Sensor U_P	0V	Sensor 0V	DATA	$\overline{\text{DATA}}$	CLOCK	$\overline{\text{CLOCK}}$	Vacant	
	●————●		●————●							

Shield on housing; U_P = Voltage supply

Sensor: The sensor line is connected internally with the corresponding power line.

Vacant pins or wires must not be used.

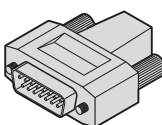
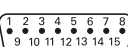
EIB output

15-pin D-sub connector, male								
  								
	Power supply				Serial data transfer		Other signals	
	4	12	2	10	8	15	1/3/5/6/7/9/11/13/14	
	U_P	Sensor U_P	0V	Sensor 0V	DATA	$\overline{\text{DATA}}$	Vacant	
	●————●		●————●					

Shield on housing; U_P = Voltage supply

Sensor: The sensor line is connected internally with the corresponding power line.

Vacant pins or wires must not be used.

HEIDENHAIN

DR. JOHANNES HEIDENHAIN GmbH

Dr.-Johannes-Heidenhain-Straße 5

83301 Traunreut, Germany

☎ +49 8669 31-0

FAX +49 8669 32-5061

E-mail: info@heidenhain.de

www.heidenhain.de

This Product Information supersedes all previous editions, which thereby become invalid. The basis for ordering from HEIDENHAIN is always the Product Information document edition valid when the order is made.

Related documents: Adhere to the information in the following documents to ensure the correct and intended operation of the encoder:

- *Interface Electronics Product Overview*
- *Interfaces of HEIDENHAIN Encoders Brochure*

598160-xx

1078628-xx