

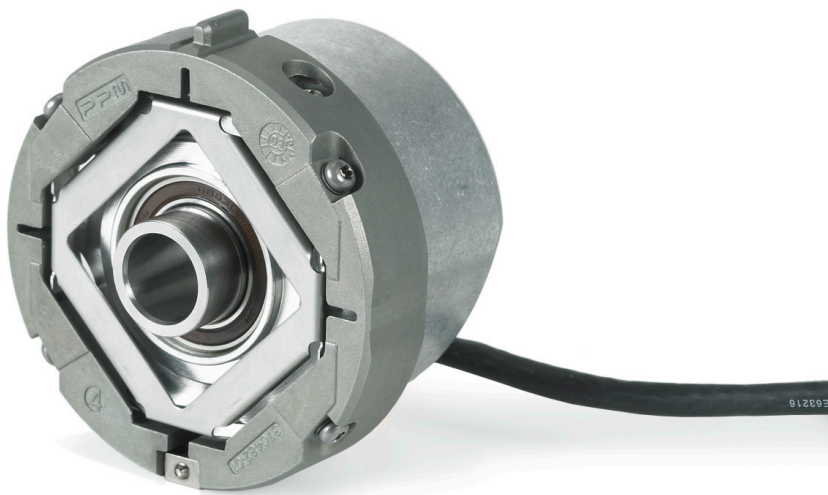

HEIDENHAIN



Product Information

ECN 425 **EQN 437**

Absolute Rotary Encoders with
Hollow Shaft and Expanding
Ring Coupling for Safety-Related
Applications

**Functional
Safety**

ECN 425, EQN 437

Rotary encoders for absolute position values with safe singleturn information

- Installation diameter 65 mm
- Expanding ring coupling 07B
- Blind hollow shaft $\varnothing 12.7$ mm for axial clamping (67M)
- IP 64 protection

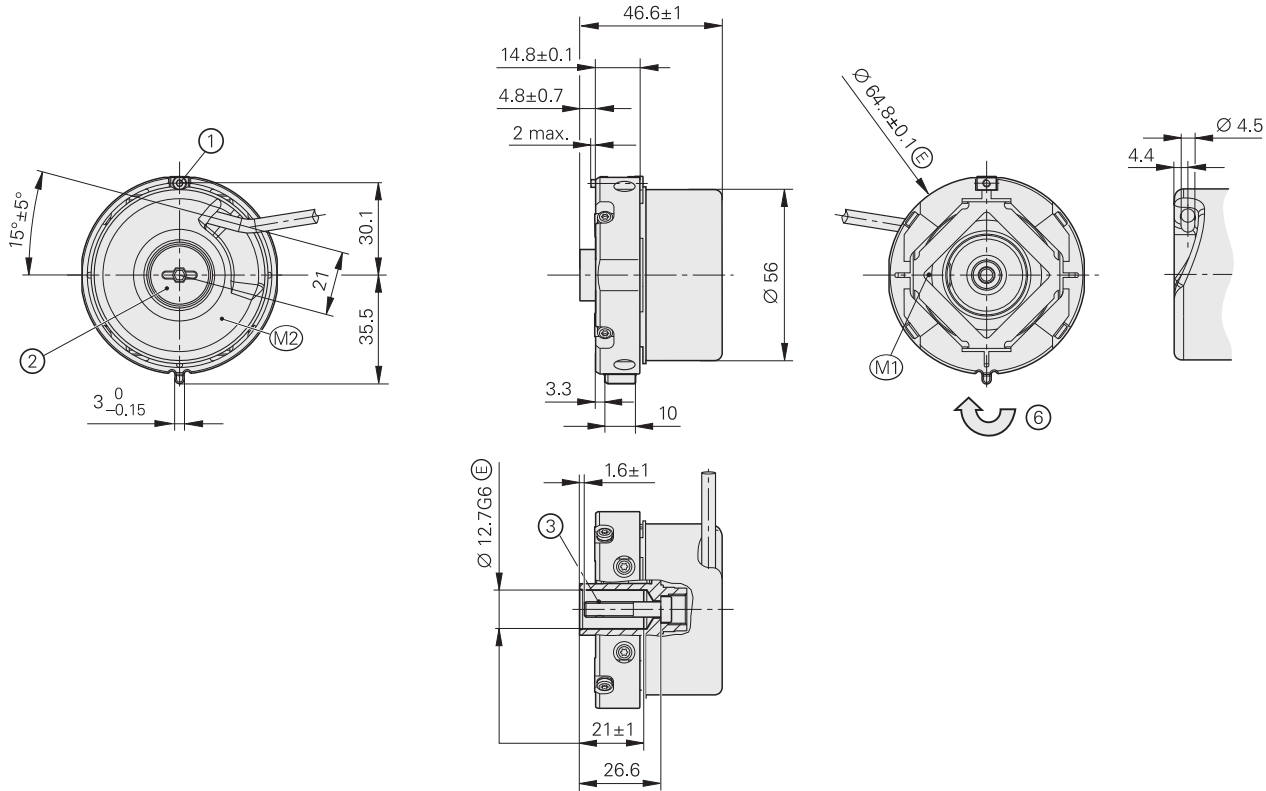
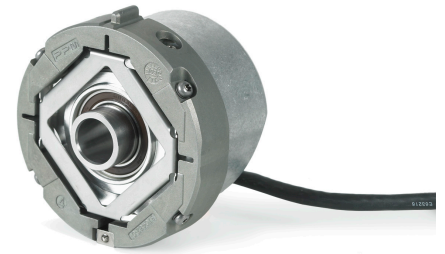

Required mating dimensions

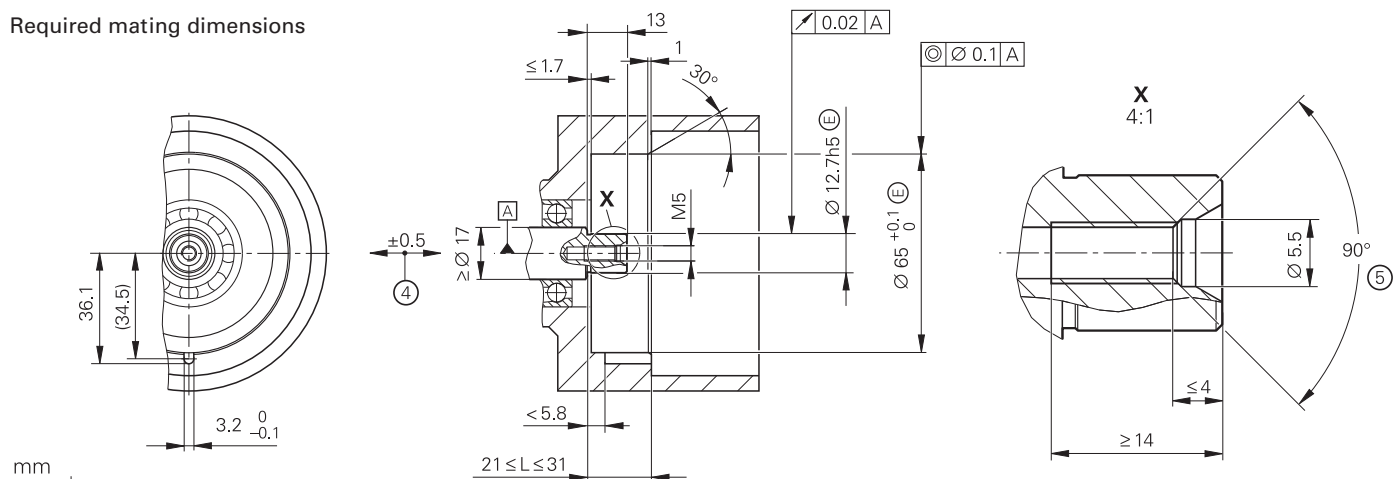

mm
 Tolerancing ISO 8015
 ISO 2768 - m H
 < 6 mm: ± 0.2 mm

- ⊠ = Bearing of mating shaft
- M1= Measuring point for operating temperature
- M2= Measuring point for vibration, see D 741714
- 1 = Clamping screw for coupling ring, width A/F 2, tightening torque 1.25–0.2 Nm
- 2 = Screw plug, widths A/F 3 and 4, tightening torque 5+0.5 Nm
- 3 = Screw DIN 6912 – M5x25 – 08.8 – MKL width A/F 4, tightening torque 5+0.5 Nm
- 4 = Compensation of mounting tolerances and thermal expansion, no dynamic motion permitted
- 5 = Chamfer is obligatory at start of thread for materially bonding anti-rotation lock
- 6 = Direction of shaft rotation for output signals as per the interface description

| Specifications | ECN 425 – Singleturm | EQN 437 – Multiturm |
|--|--|--|
| These data apply for | ID 678920-01 | ID 678922-01 |
| Functional safety for applications up to | <p>As single-encoder system for monitoring functions</p> <ul style="list-style-type: none"> SIL 1 according to EN 61508 (further basis for testing: EN 61800-5-2) Category 2, PL c according to EN ISO 13849-1:2008 <p>As single-encoder system for closed-loop functions</p> <ul style="list-style-type: none"> SIL 2 according to EN 61508 (further basis for testing: EN 61800-5-2) Category 3, PL d according to EN ISO 13849-1:2008 <p>Safe in the singleturm range</p> | |
| PFH | $\leq 10 \times 10^{-9}$ (probability of a dangerous failure per hour) | |
| Safe position ¹⁾ | <p>Encoder: $\pm 1.76^\circ$ (safety-related measuring step: SM = 0.7°)</p> <p>Mechanical coupling: $\pm 2^\circ$ (fault exclusion for loosening of shaft and stator coupling, designed for accelerations of $\leq 300 \text{ m/s}^2$)</p> | |
| Interface | EnDat 2.2 | |
| Ordering designation | EnDat22 | |
| Position values/revolution | 33 554 432 (25 bits) | |
| Revolutions | - | 4096 (12 bits) |
| Calculation time t_{cal} Clock frequency | $\leq 7 \mu\text{s}$ $\leq 8 \text{ MHz}$ | |
| System accuracy | $\pm 20''$ | |
| Electrical connection | Cable 1 m, with M12 coupling (male, 8-pin) | |
| Cable length | $\leq 100 \text{ m}$ (see EnDat description in the <i>Interfaces of HEIDENHAIN Encoders</i> catalog) | |
| Power supply voltage | 3.6 V to 14 V DC | |
| Power consumption ²⁾ (maximum) | <p>At 3.6 V: $\leq 600 \text{ mW}$</p> <p>At 14 V: $\leq 700 \text{ mW}$</p> | <p>At 3.6 V: $\leq 700 \text{ mW}$</p> <p>At 14 V: $\leq 800 \text{ mW}$</p> |
| Current consumption (typical) | At 5 V: 85 mA (without load) | At 5 V: 105 mA (without load) |
| Shaft | Blind hollow shaft for axial clamping $\varnothing 12.7 \text{ mm}$ (67M) | |
| Shaft speed | $\leq 12\,000 \text{ min}^{-1}$ | |
| Starting torque at 20 °C | $\leq 0.01 \text{ Nm}$ | |
| Moment of inertia of rotor | $3.6 \times 10^{-6} \text{ kgm}^2$ | |
| Angular acceleration of rotor | $\leq 5 \times 10^4 \text{ rad/s}^2$ | |
| Natural frequency of stator coupling | $\geq 1700 \text{ Hz}$ | |
| Axial motion of measured shaft | $\leq \pm 0.5 \text{ mm}$ | |
| Vibration 55 Hz to 2000 Hz ³⁾ Shock 6 ms | $\leq 300 \text{ m/s}^2$ (EN 60 068-2-6); 10 Hz to 55 Hz constant over distance 4.9 mm peak to peak $\leq 2000 \text{ m/s}^2$ (EN 60 068-2-27) | |
| Min. operating temperature | Stationary cable: $-30 \text{ }^\circ\text{C}$; Moving cable: $-10 \text{ }^\circ\text{C}$ | |
| Max. operating temperature | 100 °C | |
| Threshold sensitivity Error message for exceeded temperature | 125 °C (measuring accuracy of internal temperature sensor: $\pm 7 \text{ K}$) | |
| Relative humidity | $\leq 93 \%$ (40 °C/21 d as per EN 60 068-2-78); without condensation | |
| Degree of protection EN 60 529 | IP 64 (see <i>Insulation</i> under <i>General mechanical information</i> in the <i>Encoders for Servo Drives</i> catalog; contamination through ingress of liquids must be avoided) | |
| Weight | $\approx 0.25 \text{ kg}$ | |

1) Further tolerances may occur in subsequent electronics after position value comparison (contact manufacturer of subsequent electr.)
2) See *General electrical information* in the *Interfaces of HEIDENHAIN Encoders* catalog

Mounting

The blind hollow shaft of the rotary encoder is slid onto the motor's drive shaft and fastened with a central screw. It is particularly important to ensure that the positive-locking element of the stator coupling securely engages the corresponding slot in the mating part. A screw with materially bonding anti-rotation lock is to be used (see *Mounting accessories*). The stator coupling is clamped by an axially tightened screw in a location bore.

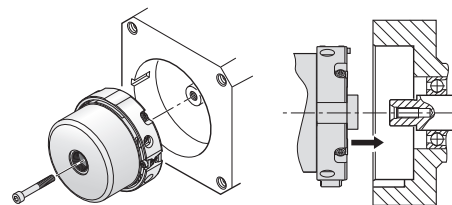

Conditions required on the motor side for a safe mechanical connection:

| | Mating shaft | Mating stator |
|--|---|---|
| Material | Steel | Aluminum |
| Tensile strength R_m | $\geq 600 \text{ N/mm}^2$ | $\geq 220 \text{ N/mm}^2$ |
| Interface pressure P_G | $\geq 500 \text{ N/mm}^2$ | $\geq 200 \text{ N/mm}^2$ |
| Surface roughness R_z | $\leq 10 \mu\text{m}$ | $\leq 10 \mu\text{m}$ |
| Coefficient of expansion α_{therm} | $(10 \text{ to } 17) \times 10^{-6} \text{ K}^{-1}$ | $\leq 25 \times 10^{-6} \text{ K}^{-1}$ |

The following maximum torque M_{max} is to be used when designing the mechanical fault exclusion for the shaft connection:

$$M_{\text{max}} = J \times \alpha + 0.2 \text{ Nm}$$

where

J: Rotor moment of inertia (see Specifications of the encoder)

α : Rotor angular acceleration (see Specifications of the encoder)

The customer's mechanical design must ensure that the torque M_{actl} actually occurring in the application can be transmitted. This M_{actl} can be smaller than the M_{max} to be considered for designing the fault exclusion.

Mounting accessories

Screws

Screws (central screw, mounting screws) are not included in delivery. They can be ordered separately. The screws from HEIDENHAIN feature a coating as per DIN 267-27 which, after hardening, provides a materially bonding anti-rotation lock. For this reason the screws cannot be reused. Unused screws are not storable indefinitely. The minimum shelf life is 2 years (storage at $\leq 30 \text{ }^\circ\text{C}$ and $\leq 65 \%$ relative humidity). The expiration date is printed on the package.

| ECN 1325, EQN 1337 | Screws ¹⁾ | | Lot size |
|---------------------------------------|-------------------------|--------------|------------------|
| Central screw for fastening the shaft | DIN 6912-M5×25-08.8-MKL | ID 202264-55 | 10 or 100 pieces |

1) With coating for materially bonding anti-rotation lock

Please note: The adhesive on the screws with materially bonding coating hardens quickly. Screw insertion and application of tightening torque must therefore take no longer than 5 minutes (see dimension drawing). The required strength is attained after 6 hours at room temperature. The curing time increases with decreasing temperature. Curing temperatures below $5 \text{ }^\circ\text{C}$ are not permissible.

For further mounting information and mounting aids see the Mounting Instructions and the *Encoders for Servo Drives* catalog.

Integrated temperature evaluation

This rotary encoder features a temperature sensor integrated in the encoder electronics. The digitized temperature value is transmitted purely serially over the EnDat protocol. It must be noted that temperature measurement and transmission is not "safe" in the sense of functional safety.

With regard to the internal temperature sensor, the rotary encoder supports a dual-level cascaded signaling of exceeded temperature. It consists of an EnDat warning and an EnDat error message.





In accordance with the EnDat specification, when the warning threshold of the internal temperature sensor is reached, an EnDat warning is transmitted (EnDat memory area "Operating condition," word 1 – "warnings," bit 2¹ – "temperature exceeded"). This warning threshold for the internal temperature sensor is saved in the EnDat memory area "Operating parameters," word 6 – "Threshold sensitivity warning bit for exceeded temperature," and can be individually adjusted. A device-specific default value is saved here when the encoder is shipped. The temperature measured by the internal temperature sensor is higher by a device-specific and application-specific amount than the temperature at the measuring point M1 according to the dimension drawing.

The rotary encoder features a further, but nonadjustable, threshold sensitivity for the EnDat error message "Temperature exceeded" of the internal temperature sensor which, when triggered, transmits an EnDat error message (EnDat memory area "Operating condition," word 0 – "Error messages," bit 2² – "Position," and in the additional datum 2 "Operating condition error sources", bit 2⁶ – "Temperature exceeded"). This threshold sensitivity depends on the encoder and is shown in the specifications.

Depending on the application, HEIDENHAIN recommends adjusting the threshold sensitivity so that it lies below the threshold sensitivity for the EnDat error message "Temperature exceeded" by a sufficient value. Compliance with the permissible operating temperature with respect to the measuring point M1 is definitive for the intended use of the encoder.

Electrical connection

Cables with M12 connecting element





| | | |
|--|---|----------------------------|
| PUR connecting cable Ø 6 mm; [(4×0.14 mm ²) + (4×0.34 mm ²)]; A _P = 0.34 mm ² | | |
| Complete with M12 connector (female) and M12 coupling (male), 8-pin |  | ID 368330-xx |
| Complete with M12 connector (female), 8-pin and D-sub connector (female), 15-pin |  | ID 533627-xx |
| Complete with M12 connector (female), 8-pin and D-sub connector (male), 15-pin |  | ID 524599-xx |
| With one M12 connector (female), 8-pin |  | ID 634265-xx ¹⁾ |

A_P: Cross section of power supply lines

1) Connecting element must be suitable for the maximum clock frequency used

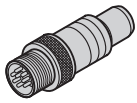
Note for safety-related applications: Provide bit error rate as per specification 533095!

Pin layout

| | | | | | | | | |
|---|--|-----------------------------|-------------|-------------------|--|-------------|--------------|--------------|
| 8-pin coupling M12 | | | | | | | | |
|  |  | | | |  | | | |
| | Power supply | | | | Absolute position values | | | |
|  | 8 | 2 | 5 | 1 | 3 | 4 | 7 | 6 |
| | U_P | Sensor U_P | 0 V | Sensor 0 V | DATA | DATA | CLOCK | CLOCK |
|  | Brown/Green | Blue | White/Green | White | Gray | Pink | Violet | Yellow |

Cable shield connected to housing; **U_P** = Power supply

Sensor: The sensor line is connected in the encoder with the corresponding power line

Vacant pins or wires must not be used!

Note for safety-related applications: Only completely assembled HEIDENHAIN cables are qualified. Exchange connectors or modify cables only after consultation with HEIDENHAIN Traunreut.

HEIDENHAIN

DR. JOHANNES HEIDENHAIN GmbH

Dr.-Johannes-Heidenhain-Straße 5

83301 Traunreut, Germany

☎ +49 8669 31-0

☎ +49 8669 5061

E-mail: info@heidenhain.de

www.heidenhain.de

598340 · 02 · A · 02 · 4/2014 · PDF

This Product Information supersedes all previous editions, which thereby become invalid. The basis for ordering from HEIDENHAIN is always the Product Information valid when the contract is made.

Related documents: Comply with the requirements described in the following documents to ensure the correct operation of the encoder:

- *Encoders for Servo Drives* catalog: 208922-xx
- *ECN 425, EQN 437* Mounting Instructions: 722594-xx
- *Safety-Related Position Measuring Systems* Technical Information: 596632-xx
- For implementation in a safe control or inverter: *Specification*: 533095