



HEIDENHAIN



Product Information

EIB 5000

Sensor Boxes for
Temperature Measurement
of Direct Drive Motors

HEIDENHAIN EIB 5000 sensor boxes

Sensor boxes for temperature measurement of direct drive motors

- **Reduced cabling**
- **Overload protection of the direct drive motor through monitoring of all three windings**
- **Faster response behavior to overheating through compensation of the transmission timing behavior of the temperature measurement (for direct drive motors from ETEL)**
- **More economical use of the direct drive motor through operation up to its thermal load limit**

Application

The HEIDENHAIN sensor boxes of the EIB 5000 series enable measurement of the temperature of direct drive motors. To achieve this functionality, the EIB 5000 boxes process values from up to three temperature sensors and compensate the transmission timing behavior of the temperature measurement (for direct drives from ETEL). The maximum determined temperature is relayed to the upstream control. When the sensor box is used with a HEIDENHAIN encoder, the processed temperature values can be transmitted to the upstream control along with the position data.

The compensation of the transmission timing behavior of the temperature measurement is optimized for direct drive motors from ETEL. The EIB 5000 boxes can be operated together with direct drive motors from other manufacturers as well. Please contact HEIDENHAIN for more information.

EIB 5000 series

The EIB 5000 series includes variants designed for mounting in an electrical cabinet (IP20) as well as for close-to-application temperature measurement of a direct drive motor (IP65).

The **EIB 5181** is optimized for use in an electrical cabinet in combination with controls from HEIDENHAIN. The placement in an electrical cabinet makes it possible to use DIP switches in order to configure the necessary parameters. Also, the EIB 5181 offers a universal interface solution for encoders with 1 V_{PP} EnDat 2.1, and EnDat 2.2 interfaces. The encoders must be connected to the encoder input using a 25-pin D-sub connector, since the EIB transmits the temperature value to the control as an analog value.

The **EIB 5281** is designed for encoders with the EnDat 2.1 interface. It transmits the temperature to the control as an analog value (PT 1000 emulation). Thanks to the IP65 rating, the EIB 5281 can be placed in direct proximity to the direct drive motor. This makes it possible to keep the length of the connecting cables for the temperature sensors very short. A special variant of the EIB 5281 may be necessary, depending on the design of the direct drive motor (see *Variants of the EIB 5200*).

The **EIB 5211** is designed for encoders with the EnDat 2.2 interface. The temperature value is transmitted to the control digitally as part of the protocol. Not only does the EIB 5211 have a high IP65 rating, but its purely digital data transmission offers numerous important advantages as well. The transmission technology is particularly immune to noise and achieves an increased accuracy of the temperature evaluation (also see *Emulation of PT 1000 behavior*). A special variant of the EIB 5211 may be necessary, depending on the design of the direct drive motor (see *Variants of the EIB 5200*). The EIB 5211 is optionally available with an additional switching output. Please contact HEIDENHAIN for more information.

The digitized temperature value is transmitted from the EIB 5211 to the encoder, and then from encoder over the EnDat 2.2 interface to the control. This means that the EIB 5211 can therefore not be connected to all encoders with the EnDat22 ordering designation. The encoder must be accordingly suitable for this. Suitable at present are the RCN 2001, RCN 5001, and RCN 8001 series with the ordering designation EnDat22. Please contact HEIDENHAIN for information about the availability of other encoders.

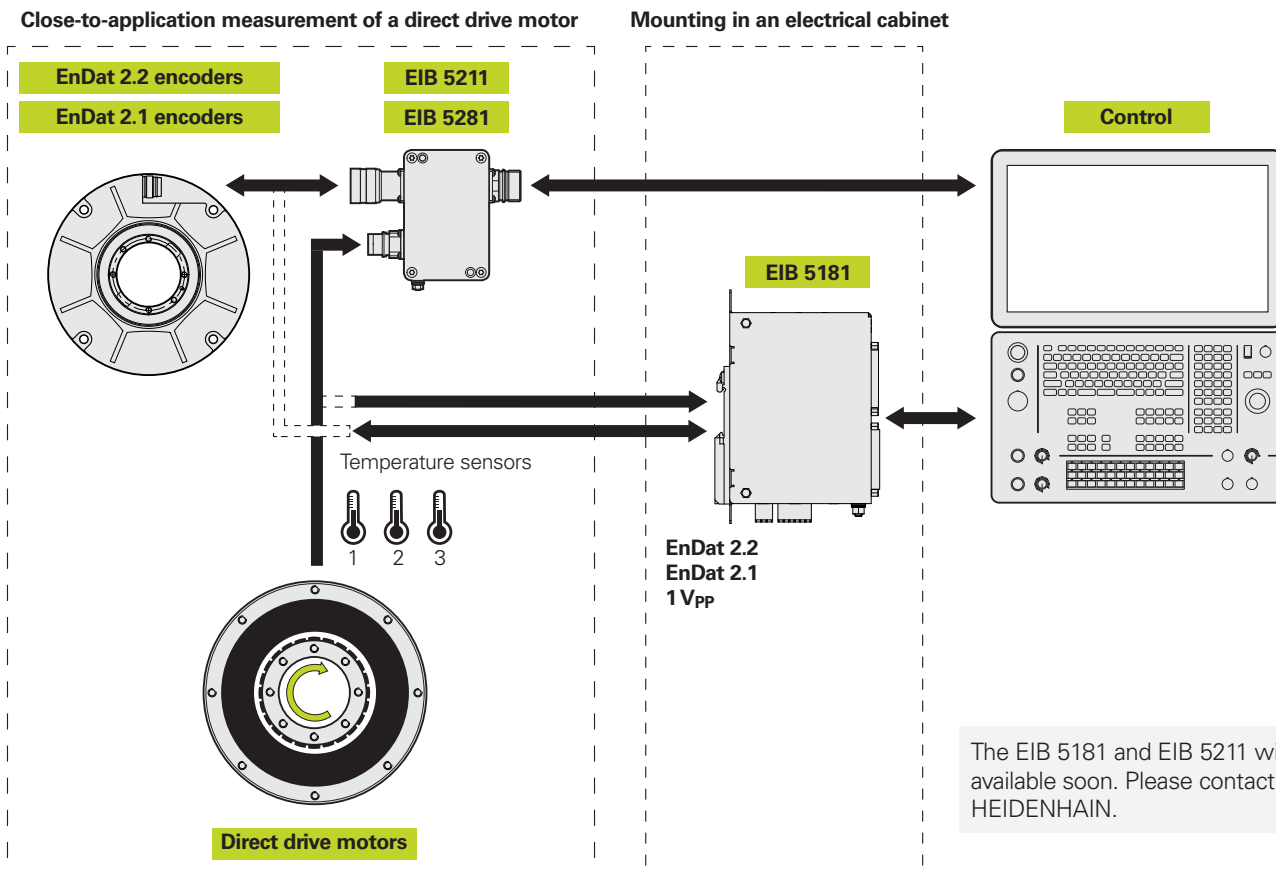

Variants of the EIB 5200

An appropriate variant of the EIB 5200 may be needed depending on the direct drive motor. Before delivery, the variant is programmed for a particular combination of the following factors:

- Configuration of the temperature sensors
- Compensation value of the transmission timing characteristics regarding the temperature measurement

Temperature sensors

The EIB 5000 enables simultaneous evaluation of up to three temperature sensors. The following sensor types can be evaluated:

- KTY 84-130
- PT 1000
- PTC
- PTC triplet

Temperature evaluation

Based on data from the sensors, the highest temperature value is determined, and the transmission timing behavior of the temperature measurement is compensated for (for ETEL direct drive motors). The resulting value is then relayed to the control. In this process, the sensor values are digitized, calculations are performed, and the determined value is converted into an equivalent analog output signal. This signal can be evaluated by the control's temperature input. With the EIB 5211 there is no conversion to analog signals. The digitally determined value is transmitted directly via the purely serial EnDat 2.2 interface. The evaluation of all three winding temperatures, as opposed to the evaluation of only one temperature sensor or PTC triplet sensor, offers significant advantages in the application and increases the economic efficiency:

- Overload protection of the direct drive motor through monitoring of all three windings
- Faster response behavior to overheating through compensation of the transmission timing behavior of the temperature measurement (for direct drive motors from ETEL)
- More economical use of the direct drive motor through operation up to its thermal load limit

Compensation of the transmission timing behavior of the temperature measurement for direct drive motors from ETEL

When a direct drive motor is required to hold a position at standstill, an asymmetric current distribution may arise. This can cause a winding to overload and lead to a rapid spike in temperature. The simplest way of detecting such an overload is through the use of three switching elements (usually PTC thermistors). However, because the measurement location and the affected components are thermally decoupled from each other, the winding may become overheated before the switching elements react. When sensors are used instead of switching elements, and when the thermal coupling (thermal model) is known, the sudden spike in temperature can be emulated through mathematical compensation of the transmission timing behavior of the temperature measurement. Switch-off occurs much earlier, thereby contributing significantly to protection of the direct drive motor. The transmission timing behavior of the temperature measurement is largely determined by the thermal coupling between the sensor and the motor winding, and by the design of the direct drive motor. Different types of direct drive motors exhibit different time constants. For ETEL direct drive motors, the exact time constants are known. On the EIB 5181 the time constant can be set using the DIP switches. For the EIB 5200 the time constant must be indicated when ordering.

Emulation of PT 1000 behavior

At the control input, the EIB 5181 and EIB 5281 emulate the resistance value of a PT 1000 sensor. In determining the temperature value, the control must provide a constant current level to ensure correct emulation and proper functioning of the control algorithms. The temperature value is then determined through the drop in voltage. When a pulsed current is provided, proper functioning cannot be guaranteed. The accuracy of the temperature evaluation is also affected by the cable length.

The EIB 5181 also emulates the behavior of a PT 1000, but additionally the DIP switches can be used to reconfigure it to emulate a KTY84-130.

Electrical safety

The EIB 5000 features increased insulation separating the motor sensor inputs from the encoder and control connections. The EIB 5000 temperature sensor inputs exhibit safe electrical separation from dangerous electric circuits in accordance with DIN EN 61010-1 and DIN EN 61800-5-1. The subsequent electronics are thus well protected.

Cascading

In certain applications (e.g., gantry motors), two direct drive motors may be controlled by means of a single encoder. To enable temperature monitoring in both direct drive motors, two EIB sensor boxes can be used in combination. These two sensor boxes must be properly configured (please contact HEIDENHAIN). The EIB 5181 is configured using DIP switches. Cascading is not possible with the EIB 5211.

Switching outputs

Variants of the EIB 5200 are available with additional switching outputs. Two switching outputs are supported:

- Error (temperature > 130 °C)
- Warning (temperature > 100 °C)

For more information, please contact HEIDENHAIN.

Monitoring functions

The EIB 5000 uses its analog temperature connection and/or the digital temperature value to output not only the temperature but other fault conditions as well:

- Sensor short
- Sensor wire breakage
- Invalid configuration
- Other errors

Power-on behavior

During the initialization phase, the maximum value is output for the temperature. The temperature value then levels out at the actual measured value.

Power supply

The power supplied by the subsequent electronics is passed along to the connected encoder by the EIB. The power required for evaluation of the temperature sensors is diverted from the incoming supply voltage by means of galvanic isolation.

EIB 5281

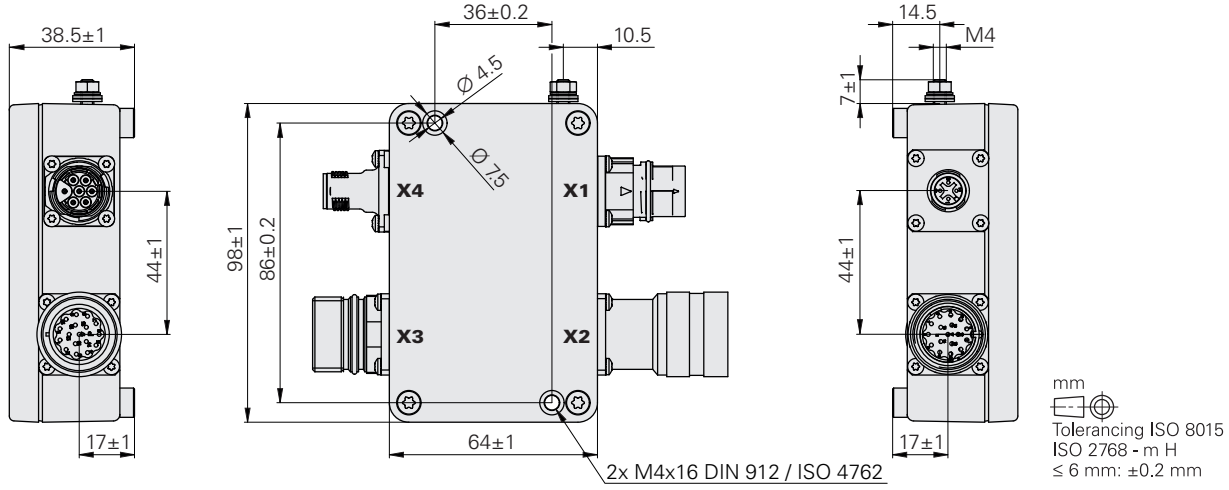

EIB 5211

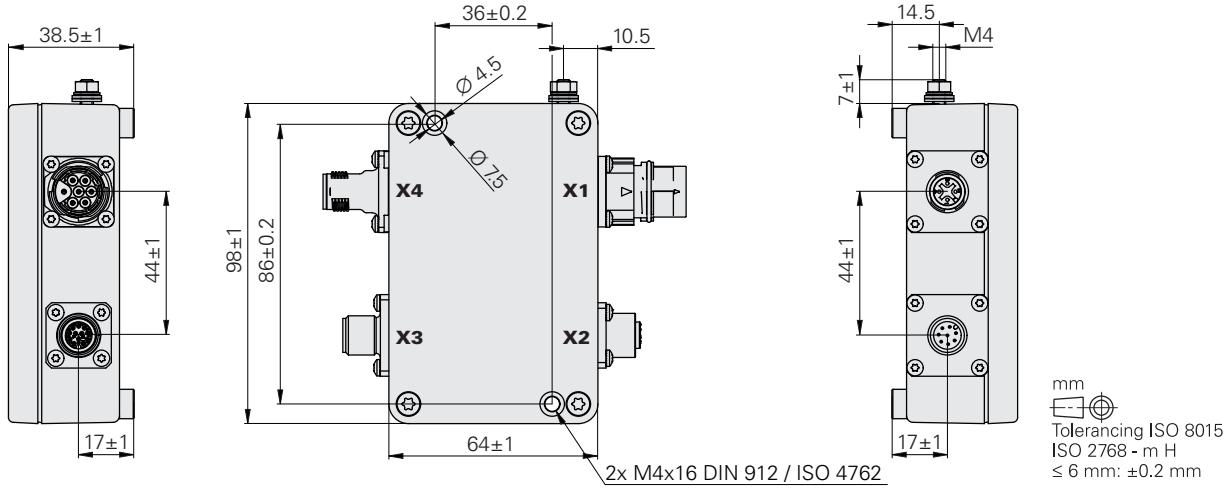

EIB 5181

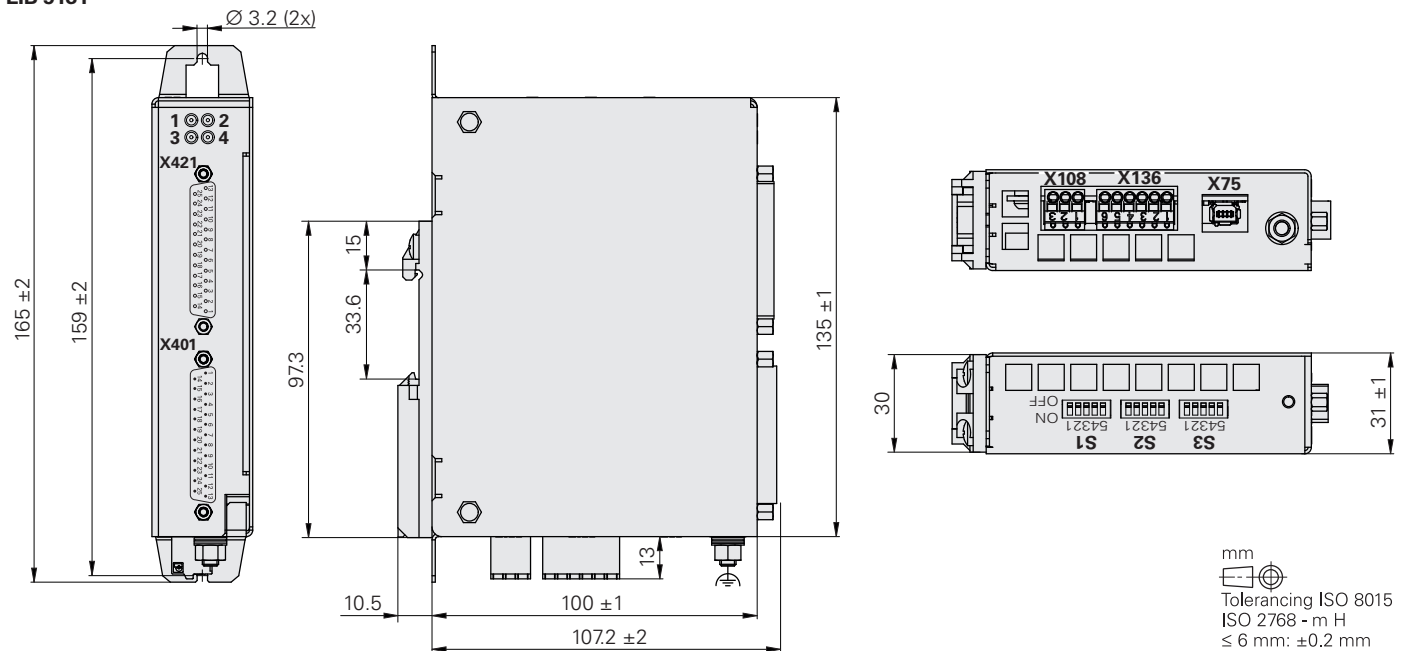

Specifications	EIB 5281	EIB 5211	EIB 5181
Functional safety	Determined by the connected encoder and subsequent electronics (including their configuration); the EIB has no effect on the safe position		
Encoder input			
Interface	EnDat 2.1	EnDat 2.2	1 V _{PP} /EnDat 2.1/EnDat 2.2
Ordering designation	EnDat01/EnDat02	EnDat22 ⁹⁾	EnDat01/EnDat02/EnDat22
Electrical connection	17-pin M23 flange socket (female) with coupling ring	12-pin M12 flange socket	25-pin D-sub connector (female)
Voltage supply of encoder	The EIB passes the supply voltage from the subsequent electronics to the connected encoder		
Cable length ¹⁾	< 6 m		< 100 m
Temperature sensor input			
Quantity	3		
Connectable sensors ²⁾	KTY 84-130, PT 1000, PTC, PTC triplet ³⁾		
Evaluation accuracy tolerance	Typically: ±1 K; maximum: ±2 K		
Time constant for temperature measurement	Please indicate when ordering		Set using DIP switches
Electrical connection	7-pin M17 flange socket (female)		6-pin header (male)
Cable length ⁴⁾	< 6 m		< 20 m
Control output			
Interface	EnDat 2.1	EnDat 2.2	1 V _{PP} /EnDat 2.1/EnDat 2.2
Ordering designation	EnDat01/EnDat02	EnDat22	EnDat01/EnDat02/EnDat22
Electrical connection	17-pin M23 flange socket (male)	8-pin M12 flange socket	25-pin D-sub connector (male)
Cable length ¹⁾	< 50 m	< 50 m	< 3 m
Supply voltage	5 V ±10 % ⁵⁾	3.6 V ... 14 V	5 V ±10 % ⁵⁾
Power consumption ⁶⁾	Typical: 200 mW; max. 300 mW	Typical: 160 mW; max. 210 mW	Typical: 250 mW; max. 350 mW
Temperature output	Emulation of PT 1000 behavior ⁷⁾	–	Emulation of PT 1000 or KTY84-130 behavior ⁷⁾
Emulation accuracy tolerance ⁸⁾	Typically: ±3 K; maximum: ±4 K	–	Typically: ±3 K; maximum: ±4 K
Operating temperature	0 °C to 70 °C		
Storage temperature	–30 °C to 70 °C		
Vibration 55 Hz to 2000 Hz Shock 11 ms	100 m/s ² (EN 60068-2-6) 300 m/s ² (EN 60068-2-27)		10 m/s ² (EN 60068-2-6) 30 m/s ² (EN 60068-2-27)
Protection EN 60529	IP65 (when engaged)		IP20
Altitude	< 2000 m above sea level		
Mass	≈ 0.5 kg		

¹⁾ Applies only to HEIDENHAIN cables; be sure to consider the voltage drop

²⁾ For further information, please refer to Temperature evaluation and Monitoring functions

³⁾ Please select when ordering; EIB 5181 is configured using DIP switches

⁴⁾ Observe the information from the motor manufacturer

⁵⁾ Take the supply voltage range of the encoder into account

⁶⁾ Without power or current consumption of the encoder; version with switching output: additional power consumption of 50 mW

⁷⁾ See Emulation of PT 1000 behavior

⁸⁾ Applies to cable lengths < 1 m

⁹⁾ The encoder must be designed for connection to the EIB 5211

Cable overviews

Adapter cables and connecting cables: 1 V_{PP} interface

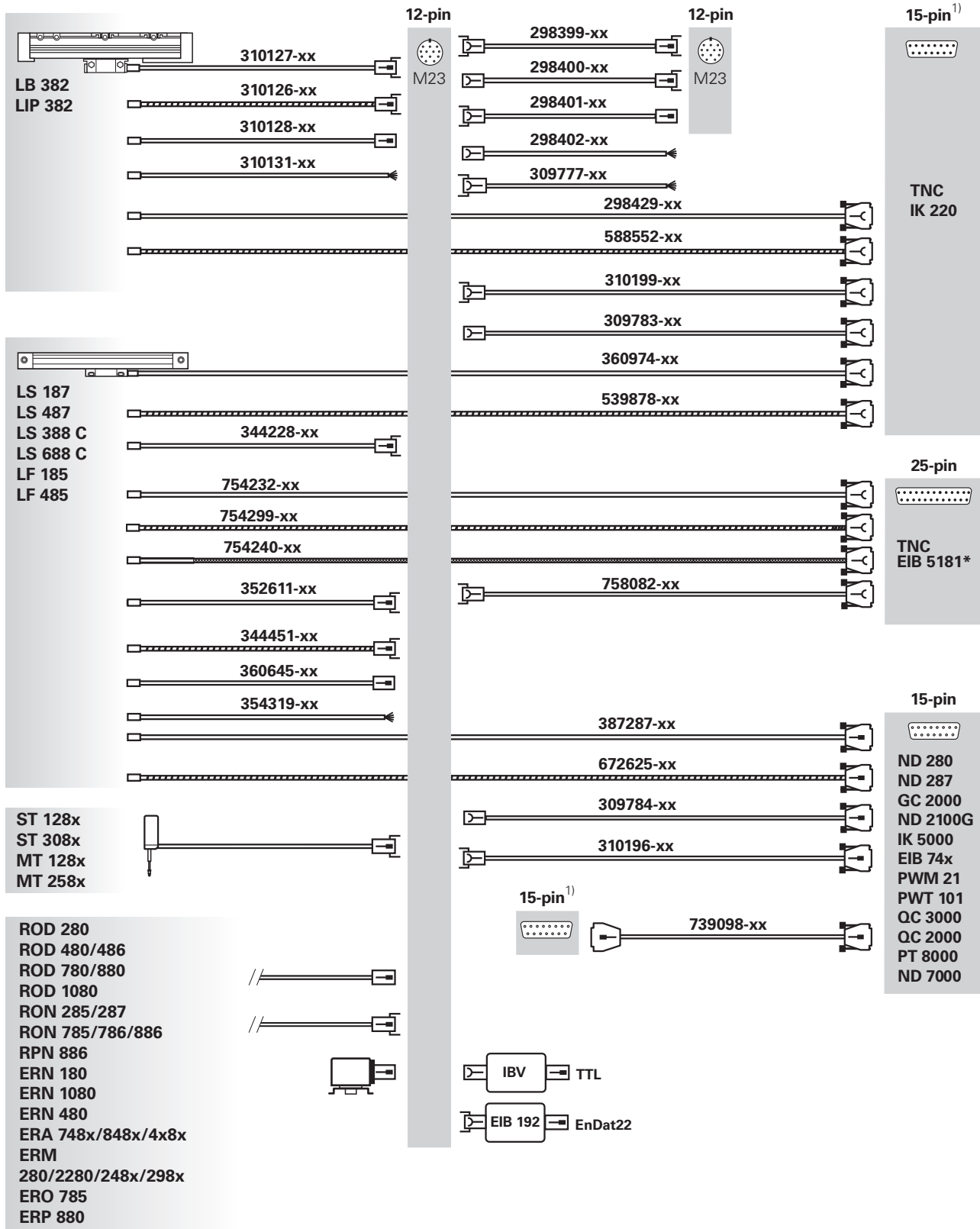

¹⁾ Identical pin layouts

* To TNC with connecting cable (ID 1287073-xx)

Adapter cables and connecting cables: EnDat interface (EnDat0x) or SSI interface

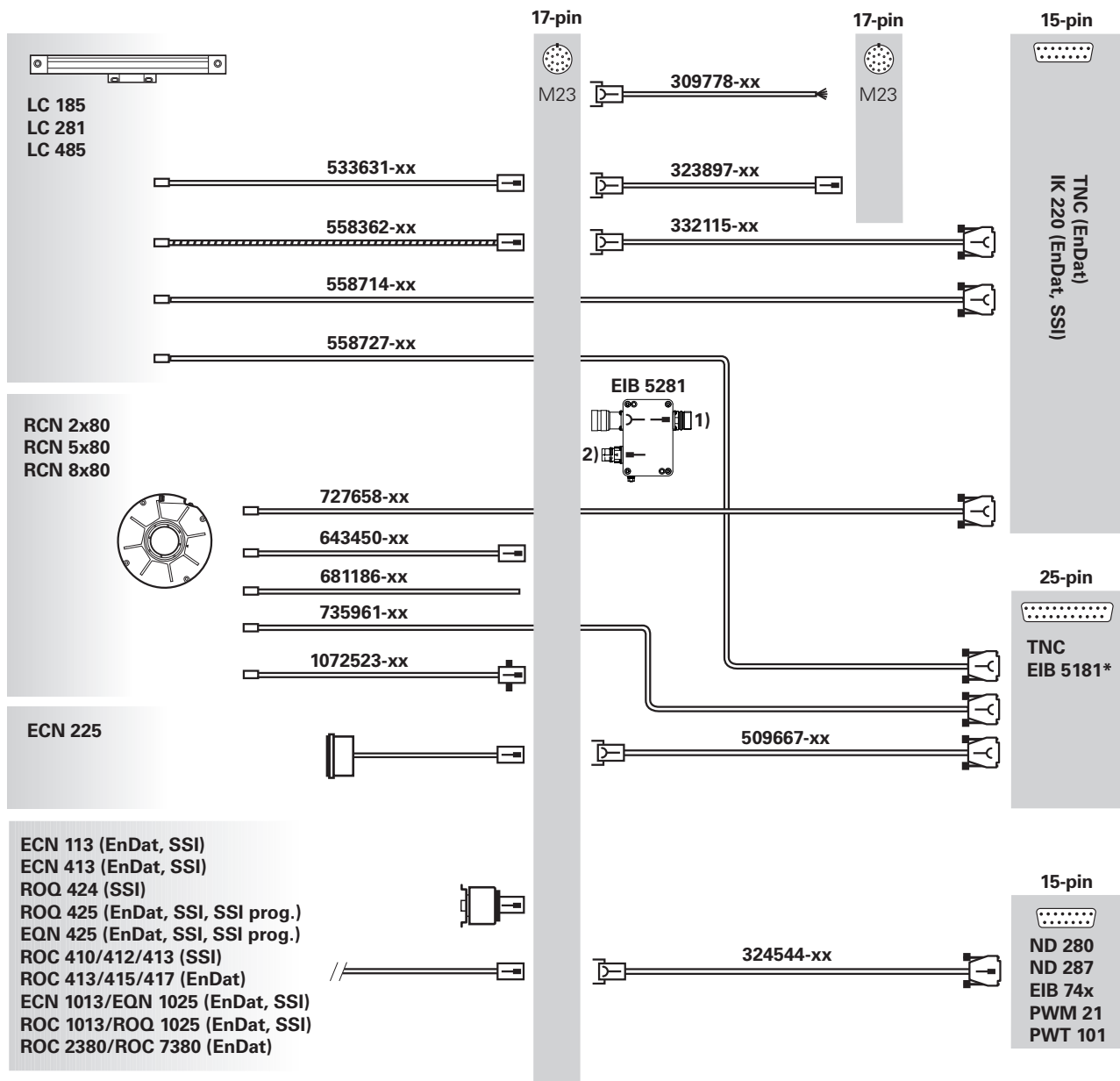

- ¹⁾ The output of the EIB 5281 for connection to a TNC (17-pin M23 (male)) has a different connector layout and must not be connected with the cables listed here.
For suitable cables, refer to the cable overviews in the TNC brochure "Information for the Machine Tool Builder"
- ²⁾ Mating connector (ID 1268541-01)
- * To TNC with connecting cable (ID 1286965-xx)

Adapter cables and connecting cables: EnDat interface (EnDat22)

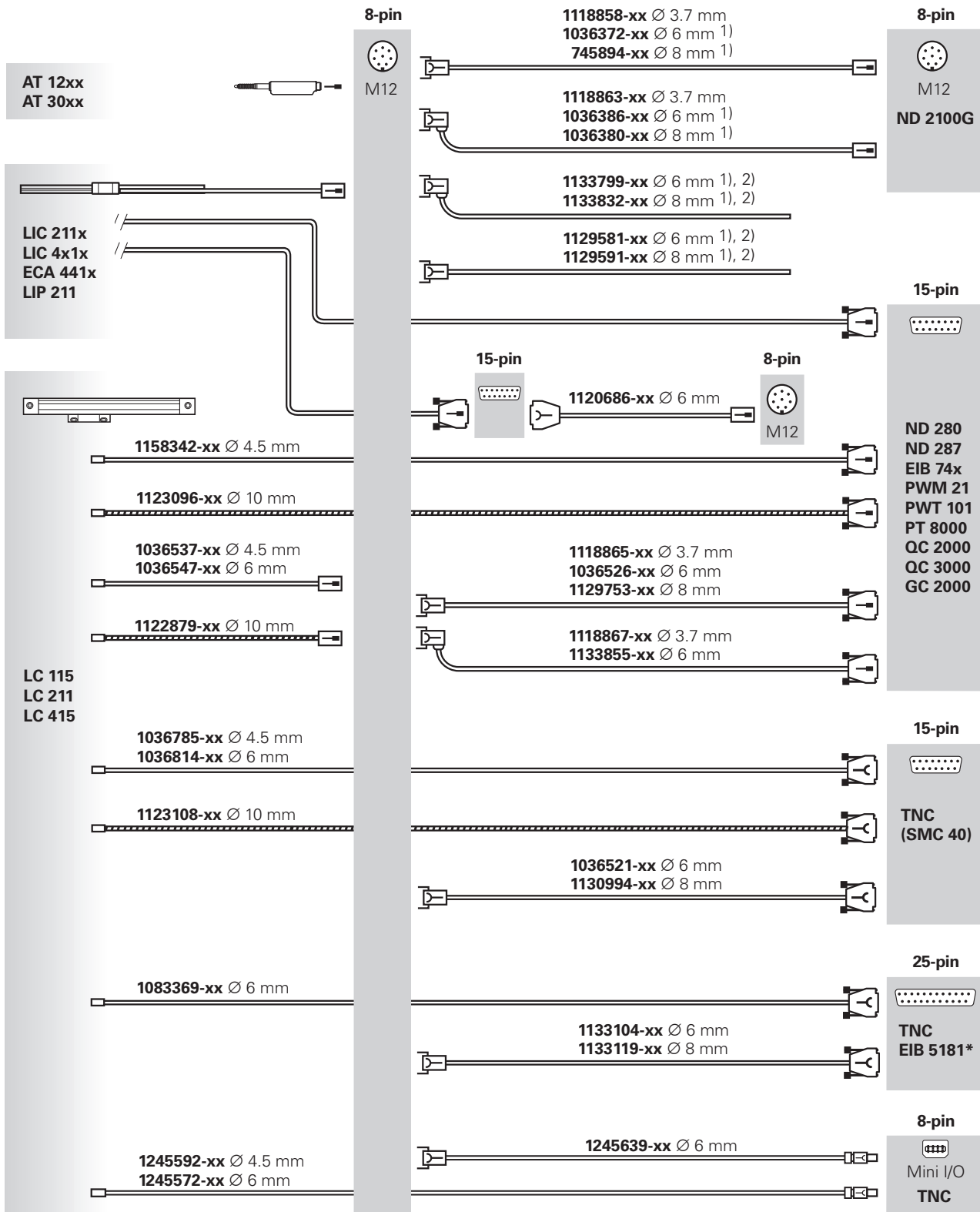

¹⁾ Also suitable for Fanuc/Mitsubishi/Panasonic/Yaskawa
²⁾ Note connecting element for 8 MHz signal transmission!
 * To TNC with connecting cable (ID 1286965-xx)

ECN 125/ECN 225
 ECN 425/EQN 437
 ECN 1023/EQN 1035
 ROC 425/ROQ 437
 ROC 1023/ROQ 1035
 ROC 2310/ROC 7310
 ERM 2410

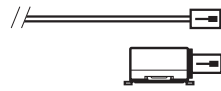

8-pin



1036372-xx Ø 6 mm 1)
 745894-xx Ø 8 mm 1)

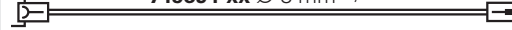

8-pin



ND 2100G

1036386-xx Ø 6 mm 1)
 1036380-xx Ø 8 mm 1)

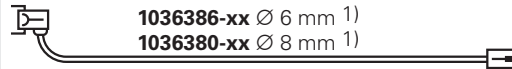

1133799-xx Ø 6 mm 1), 2)
 1133832-xx Ø 8 mm 1), 2)

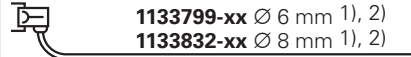

1129581-xx Ø 6 mm 1), 2)
 1129591-xx Ø 8 mm 1), 2)

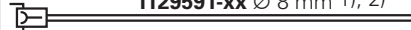

1036521-xx Ø 6 mm
 1130994-xx Ø 8 mm

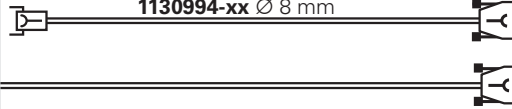

15-pin



TNC
 (SMC 40)

8-pin



Mini I/O
 TNC

1245639-xx Ø 6 mm

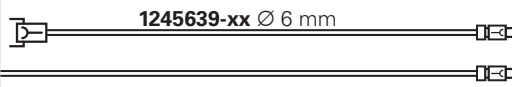

15-pin



ND 280
 ND 287
 EIB 74x
 PWM 21
 PWT 101
 PT 8000
 QC 2000
 QC 3000
 GC 2000

1036526-xx Ø 6 mm
 1129753-xx Ø 8 mm

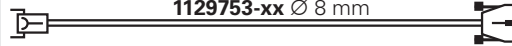

1133855-xx Ø 6 mm

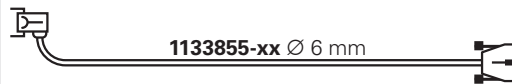

25-pin



TNC
 EIB 5181*

1133104-xx Ø 6 mm
 1133119-xx Ø 8 mm

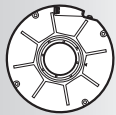
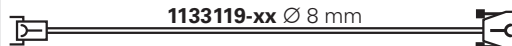

RCN 2001

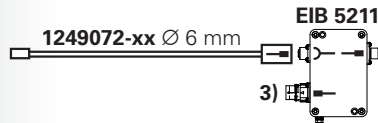

1249072-xx Ø 6 mm

EIB 5211

3)

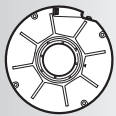

RCN 2x10
 RCN 5x10
 RCN 8x10



1119394-xx Ø 4.5 mm

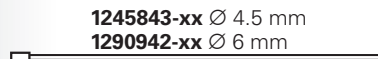

1245843-xx Ø 4.5 mm
 1290942-xx Ø 6 mm

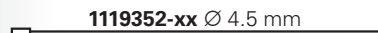

1119352-xx Ø 4.5 mm

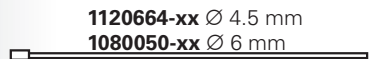

1120664-xx Ø 4.5 mm
 1080050-xx Ø 6 mm

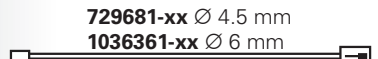

729681-xx Ø 4.5 mm
 1036361-xx Ø 6 mm



1119910-xx Ø 4.5 mm

Incremental encoders with converter

EIB 192
 EIB 1512



EIB 392

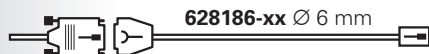

628186-xx Ø 6 mm

1) Also suitable for Fanuc/Mitsubishi/Panasonic/Yaskawa
 2) Note connecting element for 8 MHz signal transmission!
 3) Mating connector (ID 1268541-01)
 * To TNC with connecting cable (ID 1286965-xx)

HEIDENHAIN

DR. JOHANNES HEIDENHAIN GmbH

Dr.-Johannes-Heidenhain-Straße 5

83301 Traunreut, Germany

 +49 8669 31-0

 +49 8669 32-5061

E-mail: info@heidenhain.de

www.heidenhain.de

This Product Information document supersedes all previous editions, which thereby become invalid. The basis for ordering from HEIDENHAIN is always the Product Information document edition valid when the order is made.



Further information:

Comply with the requirements described in the following documents to ensure the correct and intended operation of the EIB:

- Brochure, Product Information and Mounting Instructions of the connected encoder
- Technical Information doc.: *Safety-Related Position Measuring Systems* 596632-xx
- Operating instructions: *EIB 5000* 1302631-xx